

MATERIAL HANDLING FAN Model 45-2

For more information about other BloApCo Fan models, see Bulletin 011.

Key Features

Oversized hub

Rotating outlet

- 360° at 22.5° increments.

Special fan wheel design

- All-continuous welded construction.
- Certified, dynamically balanced and stress-relieved.
- Non-clogging, with flared inlet, tapered blade and supporting back plate.

Special heavy-duty blades

- Angular blade construction adds efficiency.
- One-piece spider gusset adds strength.

Oversized chrome steel – centerless ground shaft

- Eliminates shaft deflection under heavy loading.
- Insures close tolerance between fan shaft, bearings and fan wheel.

Heavy-duty flanged bearings

- For long life.
- Heavy surge loading.

Unique shaft mount

- Allows placement of the bearings close to the wheel and drive pulley, reducing overhung bearing and shaft stress.

Exterior continuous welded fan housing

- Provides years of extended trouble-free operation.

Integral fan pedestal/motor mounting

- Arrangement 9.

OSHA approved belt guard

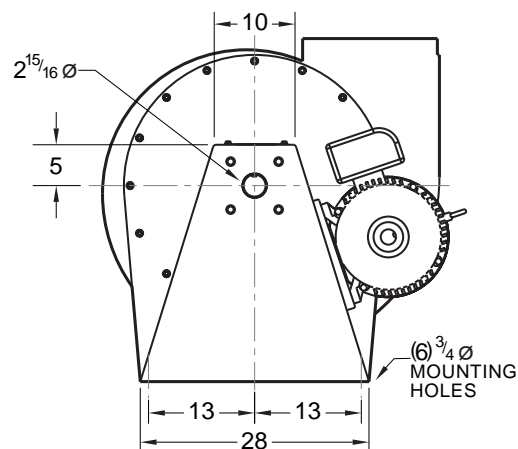
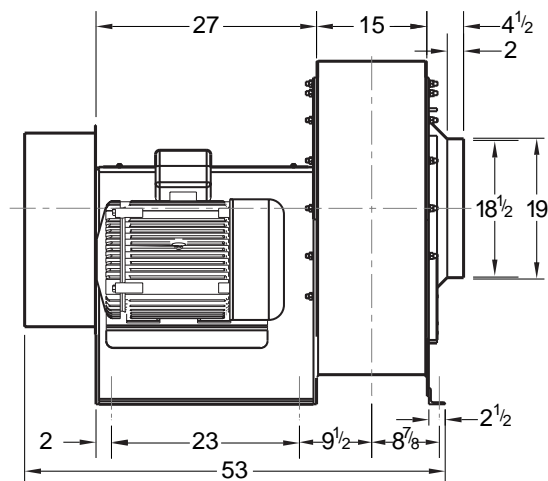
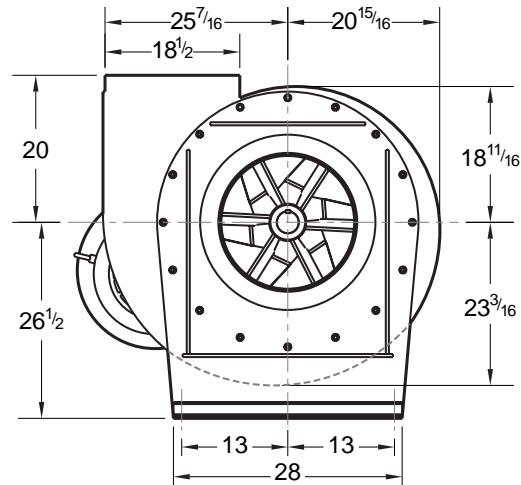

All dimensions are submittal data only, and subject to change without notice. Do not use for construction unless BloApCo certified.



Blower Application Company

N114 W 19125 Clinton Drive • P.O. Box 279 • Germantown, WI 53022-0279 • 800.959.0880 • 262.255.5580 • FAX: 262.255.3446 • bac@bloapco.com • bloapco.com

Performance Curve

Model 45-2

NOTE: This curve is extrapolated from tabular data of similar radial blade fans and is not based on actual performance tests of this particular fan.

Wheel Diameter: 31 1/2" Shaft Diameter: 2 15/16" Outlet Area: 1.809 Sq.Ft. Inlet Area: 1.867 Sq.Ft. Max RPM: 1900

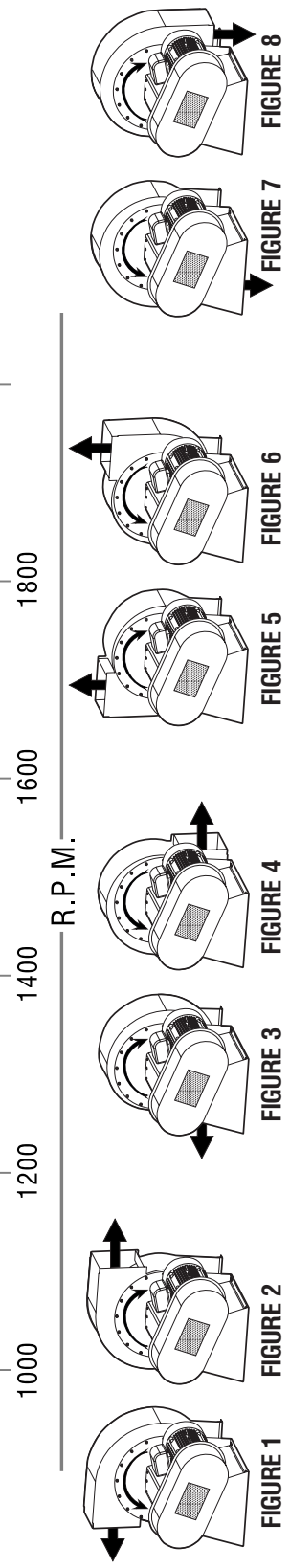
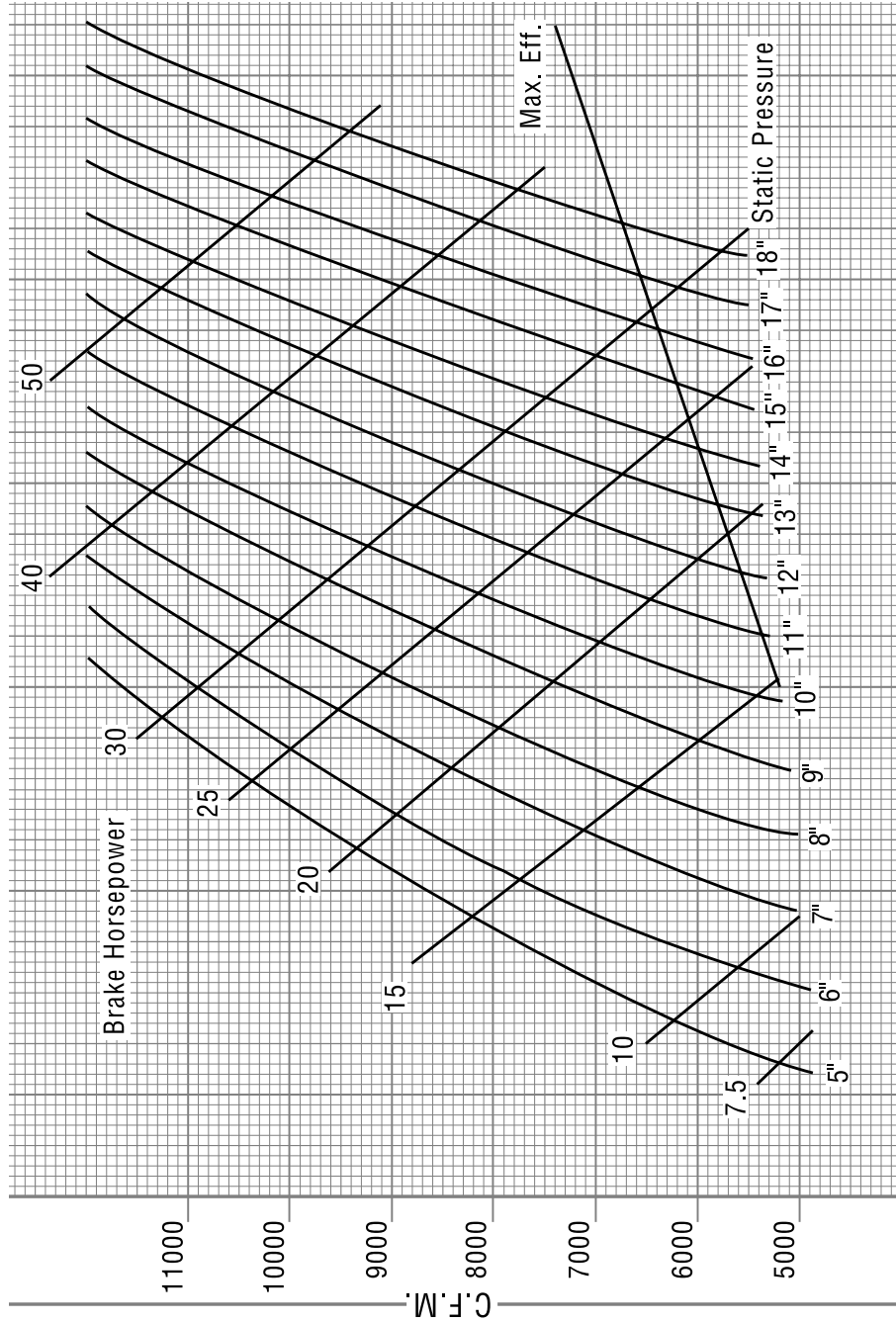

For more information about other BloApCo Fan models, see Bulletin 011.